

MT4-024/MT4-230 MT8-024/MT8-230

SMALL LINEAR THERMOELECTRIC ACTUATORS

Smart-T

PRODUCT DATA



FEATURES

- No mounting tools required (easily mounted using valve adapter)
- Water-protected housing design in all mounting positions
- Pluggable cable for easy installation and servicing
- Auxiliary switch models for driving pumps or fans
- Normally-open and normally-closed models
- Compact design allows installation in limited space
- Visual indicator showing valve position and type of action (NO or NC)
- Noiseless operation
- Reliable long-term operation
- Overload protection (4 kV) for 230 V models

SPECIFICATIONS

Max. stroke	MT4: 4 mm MT8: 8 mm
Power supply	MTx-024: 24 Vac/dc \pm 20% MTx-230: 230 Vac +10% ... -15%
Stem force	90 N
Opening/closing time	dependent on ambient temperature (see Table 3)
Ambient temperature	max. 50°C
Electrical specifications	See Table 3 on page 3.
Protection standard	IP44 in all mounting positions
Cable length	1 m, other cable lengths upon request
Cable wires	MTx-xxx: 2 x 0.5 mm ² MTx-xxxS: 4 x 0.35 mm ²
Max. permissible auxiliary switch current	MTx-xxxS: 5 (3) A
Medium temperature	max. 120 °C
Humidity	max. 95%
End position	MT4: 14.0 mm MT8: 18.0 mm

APPLICATION

Smart-T small linear actuators are used in room and zone applications for time-controlled two-point and pulse-width-modulated (PWM*) regulation of heating and cooling systems such as fan coil units, radiators, floor heating systems, chilled ceilings, and convectors.

- Fit on standard M30 x 1.5 heating/cooling valves, thermostatic radiator valves, and valve inserts for manifolds and compact radiators.
- Fit to standard closing dimensions (11.5 mm \pm 0.3 mm).
- Special valve adapters on request.

*Recommended controllers: Excel 10 and Excel 12 controllers (use with other, non-Honeywell controllers may adversely influence PWM-operation).

ORDERING INFORMATION

Table 1. Actuators

order number	action*	additional features	voltage	max. stroke
MT4-024-NC	normally closed		24 Vac/dc	4 mm
MT4-024-NO	normally open			
MT4-024-NC-2.5M	normally closed	2.5 m cable length		
MT4-024-NO-2.5M	normally open			
MT4-024S-NC	normally closed	with auxiliary switch		
MT4-024S-NO	normally open			
MT4-230-NC	normally closed		230 Vac/dc	4 mm
MT4-230-NO	normally open			
MT4-230-NC-2.5M	normally closed	2.5 m cable length		
MT4-230-NO-2.5M	normally open			
MT4-230S-NC	normally closed	with auxiliary switch		
MT4-230S-NO	normally open			
MT8-024-NC	normally closed		24 Vac/dc	8 mm
MT8-024-NO	normally open			
MT8-024-NC-2.5M	normally closed	2.5 m cable length		
MT8-024-NO-2.5M	normally open			
MT8-024S-NC	normally closed	with auxiliary switch		
MT8-024S-NO	normally open			
MT8-230-NC	normally closed		230 Vac/dc	8 mm
MT8-230-NO	normally open			
MT8-230-NC-2.5M	normally closed	2.5 m cable length		
MT8-230-NO-2.5M	normally open			
MT8-230S-NC	normally closed	with auxiliary switch		
MT8-230S-NO	normally open			

*Without power, in combination with standard 2-way valve; "normally closed" = stem extends, "normally open" = stem retracts

Table 2. Accessories

order number	description
MT-CLIP	mounting clip, 10 units
MT-ADAPT-HW	mounting adapter M30 x 1.5, 10 units
MT-ADAPT-HP	mounting adapter for Herz/Polytherm valves, 10 units
MT-CABLE-1.5M	cable suitable for MT4-024/-230 and MT8-024/-230, 10 units
MT-CABLE-2.5M	
MT-CABLE-5M	
MT-CABLE-10M	
EVA10RA	Danfoss-RA adapters, 10 units
HCA1VEL	Mounting adapter for Velta compact manifold
R453HY002	Mounting adapter for Giacomini manifold

ELECTRICAL SPECIFICATIONS

Table 3. Electrical specifications

order number	initial current*	permanent current*	power consumption*	Ø runtime for full nominal valve stroke*	
				(valve stroke: 2.5 mm) MT4	(valve stroke: 6.5 mm) MT8
MTx-024-xx, MTx-024S-xx	~0.2 A**	< 0.1 A	< 2 VA	4.0 min	6.0 min
MTx-230-xx, MTx-230S-xx	~0.4 A**	< 0.01 A	< 2 VA	4.0 min	6.5 min

* All values at nominal voltage 24 Vac/dc, 230 Vac, 50 Hz, ambient temperature: 20 °C. **Average during first 500 msec.

MOUNTING

NOTE: Connection leads must not touch piping (heat transfer).

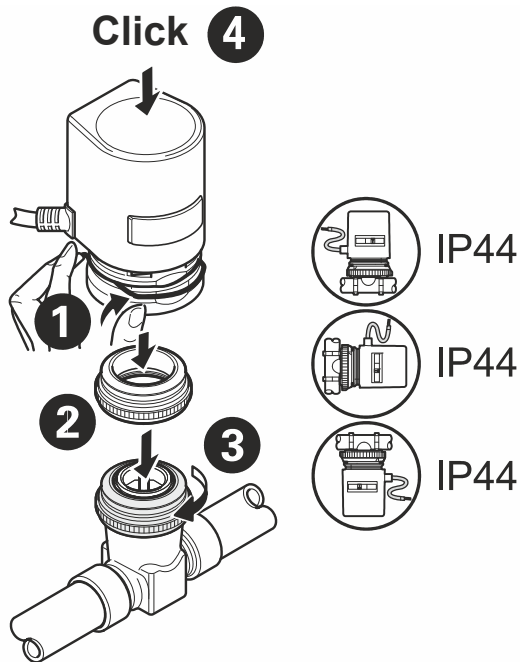

Fig. 1. Mounting / installation positions

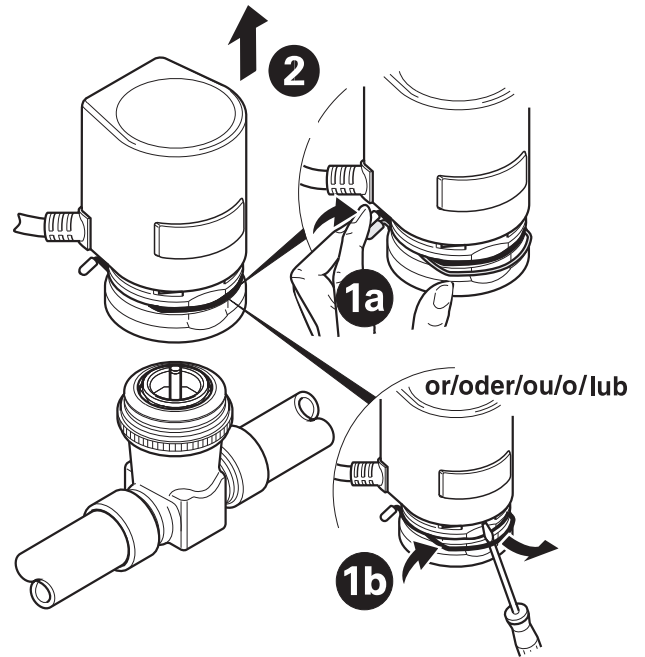

Fig. 2. Dismounting

FUNCTION

When the operating current is applied, a PTC resistor heats up a wax element. After a delay, this wax element expands, causing stroke movement.

Position Indicator

The position indicator (the red indicator behind the window on the face of the actuator) shows the model's type of action (NO or NC) as well as the current stroke position.

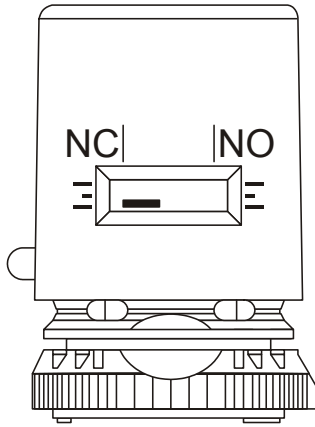

Fig. 3. Position indicator

WIRING

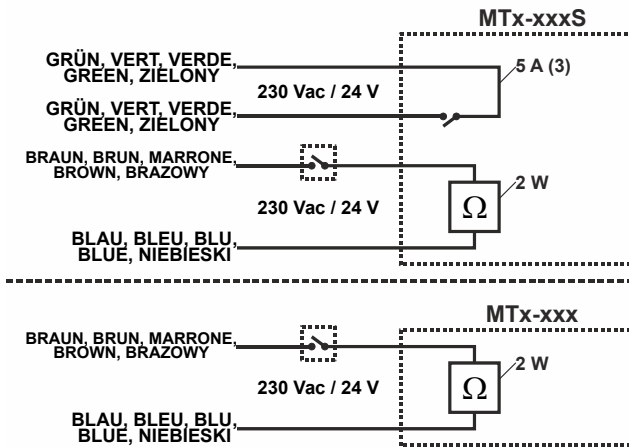

Fig. 4. Wiring diagrams

Opening and Closing Time

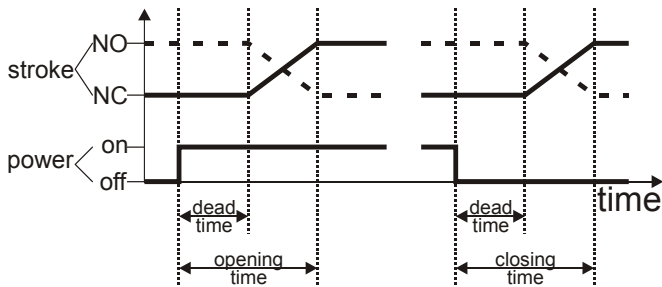

Fig. 5. Opening and closing time

NOTE: Opening and closing times depend upon ambient temperature and model.

Valve Action

Valve Action with “Typical” Valves

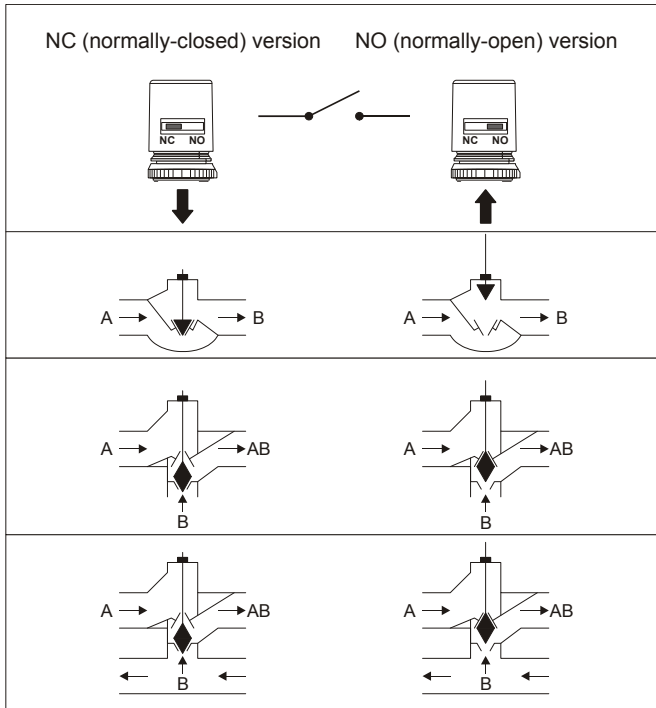

Fig. 6. Valve action

Normally open: 2-way valve, A-B open without power;
 Normally closed: 2-way valve, A-B shut without power;

NOTE: Fig. 6 is a schematic diagram showing typical valve action. Actual function can vary depending upon the individual type of valve.

Valve Action with VSxx Valves

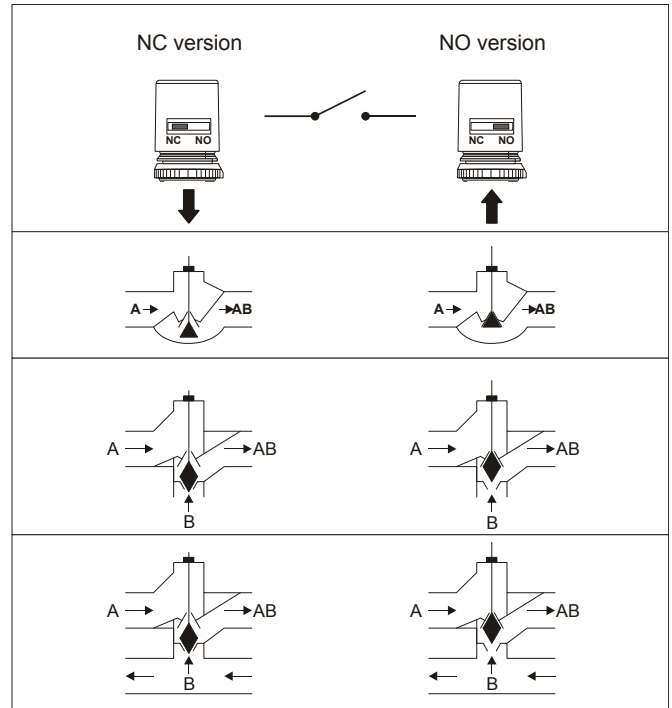

Fig. 7. Valve action with VSxx valves

DIMENSIONS

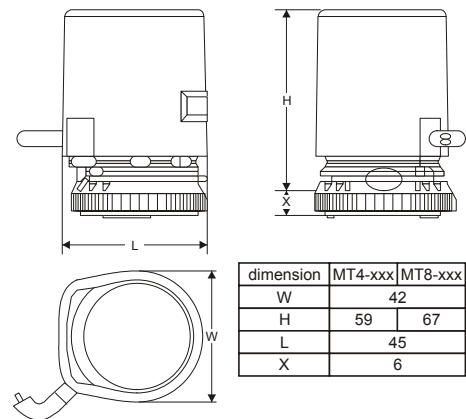

Fig. 8. Dimensions (in mm)

Honeywell

Manufactured for and on behalf of the Environmental and Combustion Controls Division of Honeywell Technologies Sàrl, Rolle, Z.A. La Pièce 16, Switzerland by its Authorized Representative:

Automation and Control Solutions

Honeywell GmbH
 Böblinger Strasse 17
 71101 Schönaich, Germany
 Phone +49 (0) 7031 637 01
 Fax +49 (0) 7031 637 740
<http://ecc.emea.honeywell.com>

EN0B-0490GE51 R0414

Subject to change without notice